

STATEMENT OF SUBDIVISION

EDEN VALLEY PROJECT
Sweetwater County, Wyoming

The subdivision of the Eden Valley Project as it appears on this plat is made with the free consent and in accordance with the desire of the United States of America as owner and proprietor thereof, pursuant to the provisions of the Acts of Congress of May 10, 1939 (53 Stat. 685, 719), of June 28, 1949 (63 Stat. 277), and of May 28, 1954 (68 Stat. 155), under delegation of authority contained in Title 7, Code of Federal Regulations, Section 600.6, as revised November 7, 1955 (20 F.R. 8517). The strips of land shown as roads upon lands owned by the United States of America are to be made the subject of a grant of easement for road purposes by separate instruments to be duly recorded.

UNITED STATES OF AMERICA

By *[Signature]*
State Conservationist
Soil Conservation Service
United States Department of Agriculture

ACKNOWLEDGMENT

STATE OF WYOMING } ss.

COUNTY OF NATRONA }

On this 2nd day of JUNE, 1959, before me the undersigned, a Notary Public in and for the County and State aforesaid, personally appeared *[Signature]*, State Conservationist, Soil Conservation Service, United States Department of Agriculture, who is personally known to me and personally known to me to be such State Conservationist and the same person who executed the within and foregoing instrument and he duly acknowledged the execution of the same for and on behalf of the United States of America.

In witness whereof, I have hereunto set my hand and affixed my official seal the day and year last above written.

[Signature]
Notary Public

My commission expires: 5/10/62

SURVEYOR'S CERTIFICATE

I hereby certify that the survey of the exterior boundaries and rights of way and the attached plat of Farm Unit E-9, Eden Valley Irrigation Project, Sweetwater County, Wyoming, were made on the ground, under my supervision; that the survey of the exterior boundaries and rights of way is accurately represented upon the plat to which this certificate is affixed, and that said plat shows the exterior boundaries of the unit of land embraced therein by true courses and distances, all of which have been tied in with the section or quarter section corners established by the official United States Government survey thereof.

Signed this 2nd day of July, 1959.





[Signature]
Project Engineer

STATE OF WYOMING } ss.
County of Sweetwater }

JUL 7 - 1959

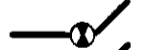
at 2:30 o'clock P.M., and
in Book 2 of Page 55
LUKE HARRIGAN,
COUNTY CLERK and RECORDER
By [Signature] Deputy

LEGEND

- Monument 
- Iron pin or bridge spike 
- Traverse point 
- Ownership boundary 

0 200 400 600
Scale

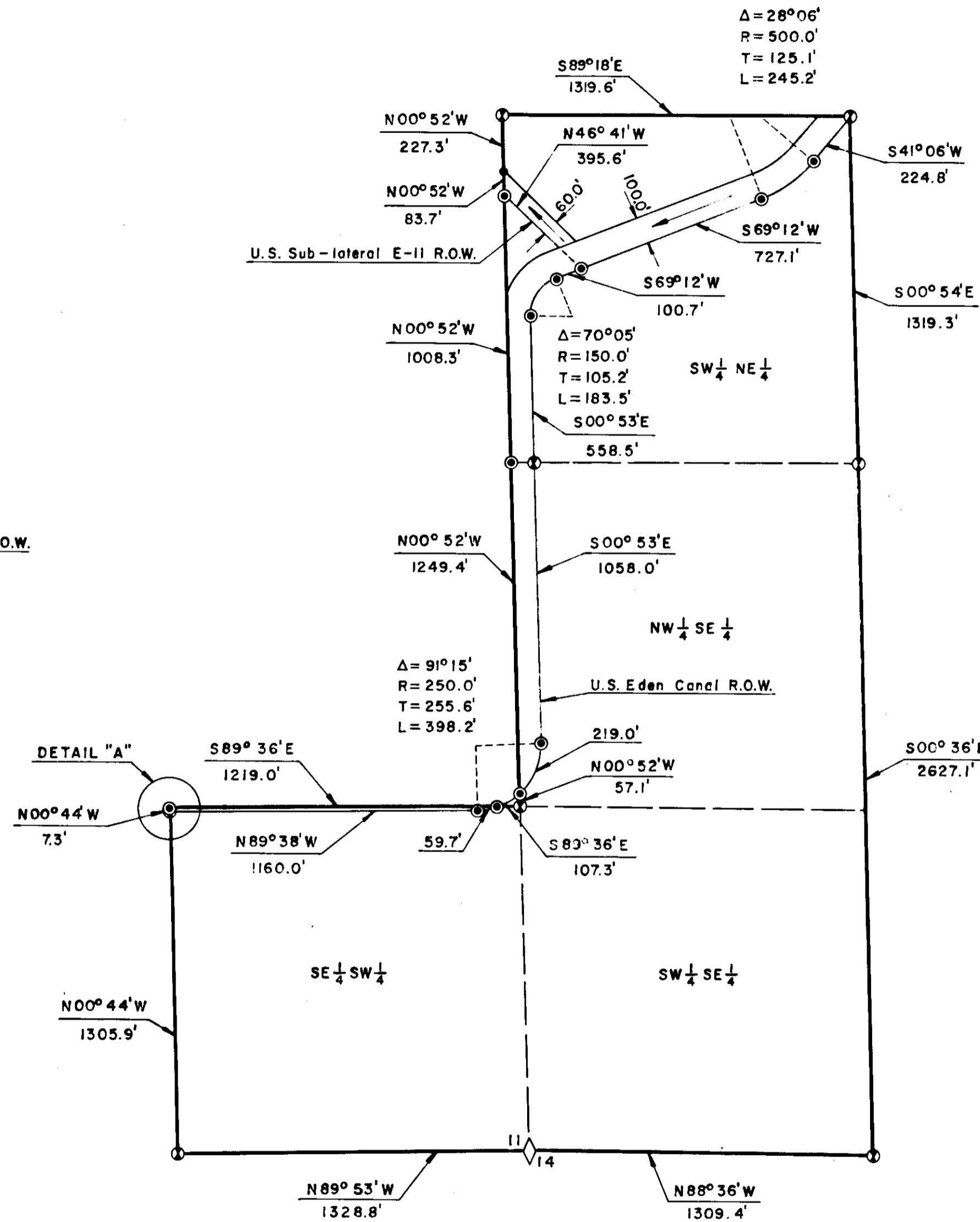
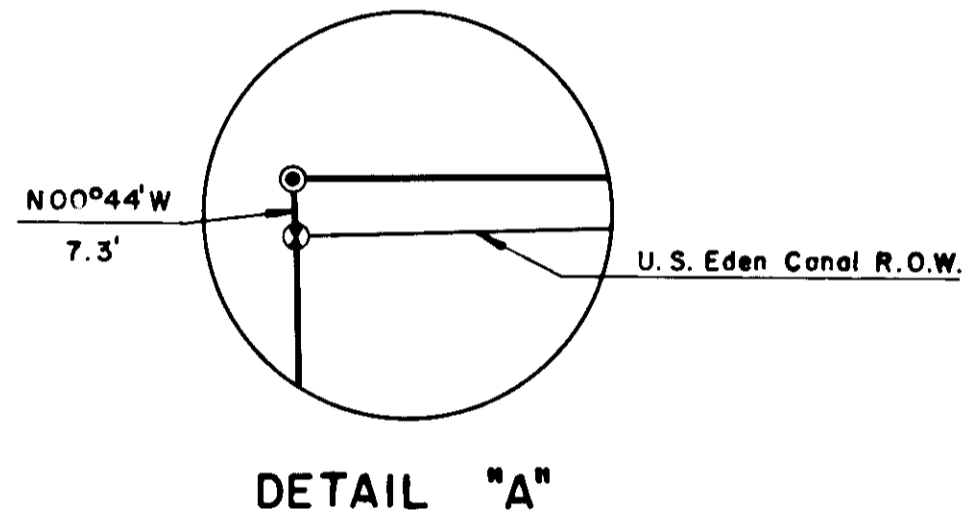
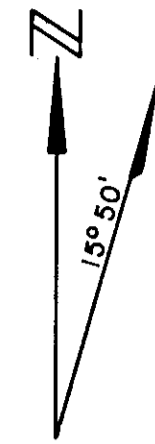

ACREAGE TABLE

Total gross acreage	158.91
Irr. wks. acreage	7.50
Road right of way acreage	
Useable acreage	151.41
Class 1	
Class 2	
Class 3	124.9
Class 4	10.4
Class 6	16.1
Total irrigable	135.3
Total non-irrigable	16.11

PLAT

FARM UNIT E-9
EDEN VALLEY PROJECT
SECTION 11, T-24-N, R-106-W
SWEETWATER COUNTY, WYOMING

U. S. DEPARTMENT OF AGRICULTURE
SOIL CONSERVATION SERVICE

Designed by R. H. D.	Date	Approved by <i>[Signature]</i>
Drawn		Title <i>[Signature]</i>
Traced	Sheet No. 1	Drawing No.
Checked	2/6/59	5, E-15, 651